

ISUZU

SPECIFICATIONS

NLS 45-150 ALL WHEEL DRIVE

NLS 45-150 ALL WHEEL DRIVE CREW



NLS 45-150 AWD Crew



NLS 45-150 AWD

AUSTRALIA'S TOP SELLING TRUCK BRAND SINCE 1989.

AT A GLANCE

GVM	4,500 kg
GCM	6,000 kg (off road) 7,000 kg (on road)
Power	110 kW @ 2,800 rpm
Torque	375 Nm @ 1,600 - 2,800 rpm

ADVANCED TECHNOLOGY

Emissions: Euro V / ADR 80/03	Anti-lock Braking System (ABS)
Meets EEV emissions standard	Hill Start Aid (HSA)
Driver and passenger airbag with seatbelt pretensioner	Electric mirrors
ECE-R29 compliant cab	Independent front torsion bar suspension
On demand part-time all wheel drive system	Cornering lamps



We share the load.

ISUZU
RELIABILITY IS EVERYTHING

NLS 45-150 ALL WHEEL DRIVE

NLS 45-150 ALL WHEEL DRIVE CREW

DRIVELINE AND CHASSIS SPECIFICATIONS

ENGINE: ISUZU 4JJ1-TCS

- Type:** 4 cylinder 16 valve with chain driven DOHC
- Displacement:** 2,999 cc
- Compression ratio:** 17.5:1
- Bore x Stroke:** 95.4 mm x 104.9 mm
- Max power (Din-Net):** 110 kW (148 HP) @ 2,800 RPM
(JIS Gross): 114 kW (153 HP) @ 2,800 RPM
- Max torque (Din-Net):** 375 Nm (277 lb.ft) @ 1,600 - 2,800 RPM
(JIS Gross): 388 Nm (286 lb.ft) @ 1,600 - 2,800 RPM
- Induction system:** Electronically controlled variable nozzle turbocharger with air-to-air intercooler.
- Fuel injection:** Direct injection high pressure common rail system.
- Emission control system:** Cooled EGR with exhaust Diesel Particulate Diffuser (DPD). ADR 80/03 (Euro V) compliant. EEV compliant

CLUTCH

- Auto adjusting hydraulic control with vacuum assistance. Single plate 300 mm diameter.
- Total lining area: 847 cm²

TRANSMISSION

ISUZU MYY-5S

- 5 speed manual. Synchromesh on gears 1-5.
- **Gear ratios (:1)**

1st	2nd	3rd	4th	5th	Rev
5.979	3.434	1.752	1.000	0.795	5.701

TRANSFER GEARBOX:

- On demand part-time all wheel drive controlled by viscous coupling.
- Ratio 1.00:1

AXLES

Front: ISUZU FD026

- Fully independent wishbone. Full floating Banjo type final drive with Birfield inner and outer joints and manual lock front hubs. 2,600 kg capacity.

Rear: ISUZU R050

- Full floating Banjo type. Four pinion limited slip differential. 5,000 kg capacity.
- Drive ratio: 4.300:1

SUSPENSION

Front:

- Torsion bar springs.
- Double acting hydraulic shock absorbers.

Rear:

- Taper leaf main spring, taper-leaf helper spring.
- Double acting hydraulic shock absorbers.

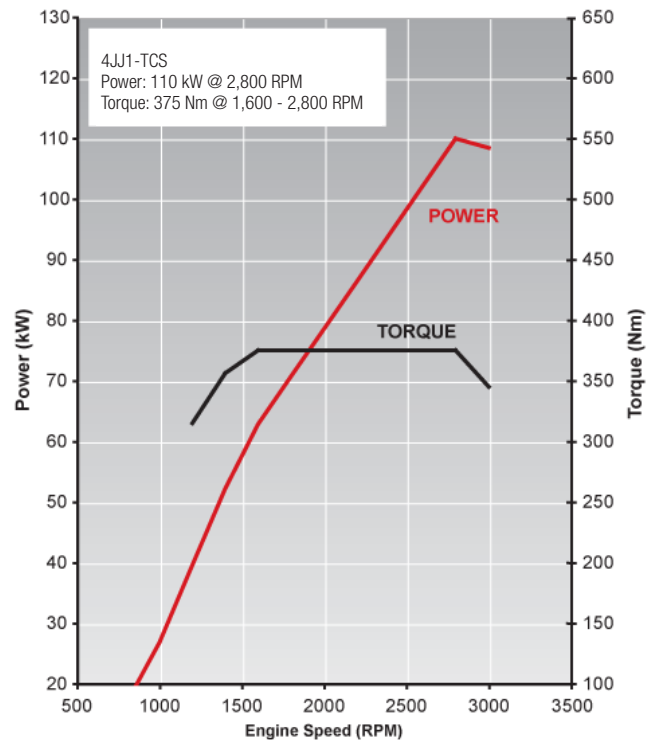

BRAKES

- Auto adjusting front disc and rear drum brakes with dual circuit hydraulic control, vacuum assistance and electronic brake force distribution (EBD).
- ABS.
- Hill Start Aid (HSA).
- Front disc diameter: 285 mm
- Rear drum size: 320 x 75 mm
- 190 mm diameter drum park brake mounted on rear of transmission.
- Vacuum controlled exhaust brake.

STEERING

- Power assisted rack and pinion.
- Turns lock to lock: 5.0
- Maximum angle: 35° (inside wheel) / 33° (outside wheel)

WHEELS AND TYRES

- 16 x 5.5J five stud steel wheels.
- 205/85R16 117/115L Bridgestone G557 Tubeless.
- Maximum tyre rating
Steer axle: 2,240 kg at 475 KPa inflation pressure
Drive axle: 4,240 kg at 475 KPa inflation pressure
- 1 frame mounted spare wheel and tyre assembly.

CHASSIS FRAME

- Cold rivetted ladder frame. SAPH440 weldable steel sidemembers.
- Frame dimensions:
 - Side rail (mm): 180 x 65 x 4.0
 - Rear frame width (mm): 700

FUEL TANK

- Frame mounted 75L steel fuel tank.
- Lockable fuel cap.

CABIN SPECIFICATIONS AND APPOINTMENTS

CAB EXTERIOR

- All steel construction. High tensile steel used for cab underframe.
 - Single cab:** Manual cab tilt to 45° with torsion bar assistance.
- Complies with ECE-R29 cab strength standard.
- Heavy duty non slip entry steps.
- 90° opening internally reinforced front doors.
- Water spray suppression guards and front mudflaps.
- Laminated windscreen with shade band.
- Two speed windscreen wipers with intermittent wipe mode.
- Halogen multi-reflector headlamps incorporating turn signals. Additional door mounted integrated side indicator/cornering lamps.
- Combination brake, turn, reverse and marker lamps, registration plate illumination lamps. Extended wiring harness. Reverse alarm.
- Heated and powered exterior main mirrors with flat glass and additional independently adjustable convex “spot” mirrors.
- Body coloured grille.
- Body coloured impact resisting polycarbonate bumper with steel backing frame.

CAB INTERIOR

- Contoured adjustable driver’s bucket seat.
- Front passenger bench seat with 2 seat capacity.
- **Crew cab:** Rear bench seat with 3 seat capacity.
- 3-point lap sash seatbelts in all outboard seating positions. Driver and outboard front passenger seatbelts fitted with pretensioner. Centre seat lap belts.
- Driver and outboard front passenger airbag.
- Door and roof pillar entry assist grips. **Crew cab:** Full width rear grab rail with ashtray.
- Full interior trim, padded roof lining and vinyl floor covering. Driver and passenger windscreen header storage shelf.
- Tilt/Telescopic adjustable steering column, soft feel urethane steering wheel.
- Electric windows.
- Central locking with remote keyless entry and immobiliser.
- Twin cup holders. 24V cigarette lighter. Dashboard hook.
- Front door mounted storage pockets and driver’s side ashtray.
- Fully integrated air conditioning and heater/demister with 4-speed fan and outlets for windscreen, side windows, face and floor.
- Interior lamp with On/Door/Off switch. **Single cab:** fluorescent type.
 - Crew cab:** standard type.
- 2 DIN, two speaker radio/CD/DVD Digital Audio Visual Entertainment (DAVE) unit with 6.2” LCD touch screen. DAB+ digital radio and fullyintegrated Bluetooth with voice recognition. 4GB internal storage for music files. USB/SD card and auxilliary input connection provisions.
- DIN sized compartment for storage or for CB radio installation.

ELECTRICAL SYSTEM

- 24 volt electrical system.
- 90 amp alternator.
- 4.0 kW starter motor.
- 2 x 80D26L (630 CCA) batteries connected in series.

DRIVER CONTROLS

- Key-operated engine start/stop and steering lock. Engine idle speed control.
- HSA slow/fast engagement control and on/off switch.
- DPD regeneration.
- All wheel drive engage switch.
- **Left side combination stalk:** Windscreen wipers, washers and exhaust brake.
- **Right side combination stalk:** Turn signals and headlamps.

INSTRUMENTATION

- Electronically driven speedometer and tachometer. Digital odometer with integrated dual tripmeter. Engine coolant temperature and fuel level gauges.
- **Warning lamps:** Check engine, oil pressure, ABS, SRS airbag, alternator charge, service brakes, park brake, seatbelt unfastened, low fuel level, transfer gearbox oil temperature.
- **Indicator lamps:** HSA, warm up system, high beam, DPD status, exhaust brake, all wheel drive engaged, turn signals.

OPTIONS AND GENUINE ACCESSORIES

Include the following (extra cost, request a brochure and further details from your Isuzu dealer):

Digital Audio Visual Entertainment unit:

- Telematics system.
- Isuzu satellite navigation including three years of free updates.
- Supports up to four camera inputs, one camera and rear microphone input active when reversing. Reversing sensors.
- Tyre pressure monitoring system.
- Cables for full iPod/iPhone/iPad compatibility and connection to other external audio visual devices.

Other:

- Airbag compatible bullbar.

ISUZU CARE

Isuzu Care gives truck owners access to products and services including Roadside Assist, Service Agreements, Extended Care, Extended Isuzu Assist and the Isuzu Care Centre. Call 1800 035 640.

WEIGHTS (kg)

Models	Ratings*		Loading Limit* (at ground)		Cab Chassis Weight #		
	GVM	GCM	Front	Rear	Front	Rear	Total
NLS 45-150 AWD	4,500	6,000 kg (off road) 7,000 kg (on road)	2,240	4,240	1,615	635	2,250
NLS 45-150 AWD CREW	4,500	6,000 kg (off road) 7,000 kg (on road)	2,240	4,240	1,705	680	2,385

* Vehicle ratings and front/rear weight limits are subject to government regulatory requirements and weight distribution analysis. Consult your Isuzu dealer to select the correct vehicle for your specific application. # Cab chassis only as supplied and including 10 litres of fuel.

DIMENSIONS (mm)

Models	WB	OAL	FOH	ROH	EA	CE	RT	ORT	CH	FFA (unladen)	RFA (unladen)	RFH (unladen)	Turn Circle (m)
													KERB TO KERB
NLS 45-150 AWD	2,740	5,230	1,100	1,390	2,020	3,667	1,425	1,860	2,200	640	750	810	10.1
NLS 45-150 AWD CREW	3,360	6,025	1,100	1,565	1,570	3,351	1,425	1,860	2,300	660	740	775	12.3

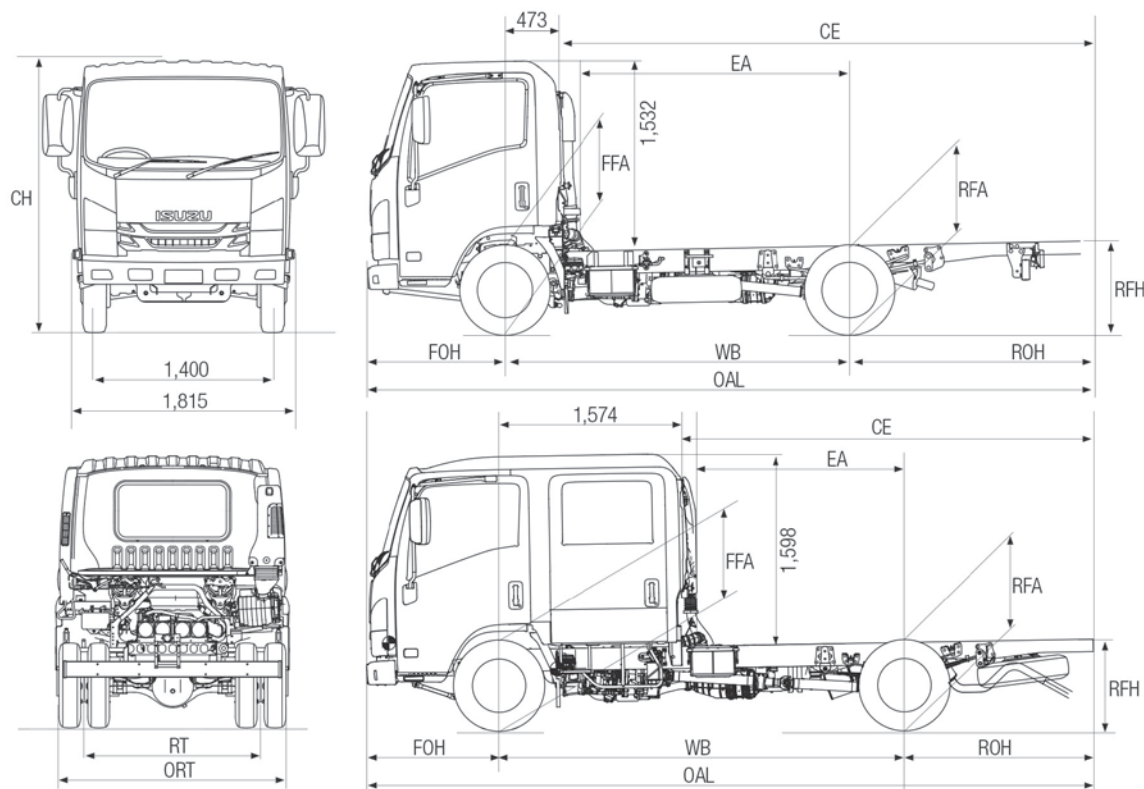

PERFORMANCE (calculated - typical paved road)

		Geared Speed* (top gear at peak power engine RPM)	Low Speed Gradeability (lowest forward gear assuming no wheel slip)	Engine Speed (top gear at 100km/h)
NLS 45-150 AWD	At 4,500 kg GVM	112 km/h @ 2,800 RPM	52%	2,500 RPM

*Maximum speed achievable depends on vehicle frontal area as well as other factors. Consult your Isuzu dealer for more detailed information.

ISUZU WARRANTIES

STANDARD ¹	
New Vehicle	3 years • 100,000km • 2,000 hours
Isuzu Assist: 24 hour roadside assistance (3 years, unlimited km)*	
EXTENDED CARE ²	
Extended Warranty: 5 years • 250,000km • 4,500 hours	
Isuzu Assist: 24 hour roadside assistance (5 years, unlimited km)	

ORDER CODES

Model	Code
NLS 45-150 AWD	NH-NLSAA-A15
NLS 45-150 AWD CREW	NH-NLSCA-B15

¹ Subject to the conditions outlined in the IAL New Vehicle Warranty, the Isuzu NLS model carries a standard factory warranty which covers the owner: (i) for the entire vehicle, for the first 36 months or 100,000 km or 2,000 hrs (whichever comes first), (ii) against cab perforation corrosion, for 36 months and unlimited kilometres. ² Extended Warranty as illustrated may be purchased to cover the owner against the failure of original components, but may exclude some components and expendable items such as oil, filters, etc. *Valid for three years from the date of new vehicle purchases. All Isuzu warranties are subject to mandatory prescribed terms under Australian Consumer law including customer guarantees. For more details visit the Isuzu website which explains Isuzu warranties in more detail, or alternatively contact your local dealer. All warranties commence from date of delivery.

ISUZU AUSTRALIA LIMITED ABN 97 006 962 572 ("IAL"). The information in this spec sheet was correct at time of printing, but all measurements, specifications and equipment are subject to change without notice. Some equipment may have been changed and/or is available at extra cost. IAL may make changes at any time without notice, in prices, colours, materials, equipment and models. IAL makes all reasonable attempts to ensure the availability of all vehicles and equipment. The information in this spec sheet is general in nature. Your Isuzu dealer can confirm all measurements, specifications and vehicle / equipment availability upon request. To the extent permitted by the law, IAL is not liable to any person as result of reliance on the content of this spec sheet.

We
share
the
load.

ISUZU
RELIABILITY IS EVERYTHING